

TARRAT KILVET
MAALIT JA LIIMAT

DEKALER SKYLTA
FÄRGER OCH LIM

STICKERS SIGN
PLATES PAINTS AND
GLUE

AUFKLEBER SCHILD
FARBE UND
KLEBSTOFF

AUTOCOLLANTS,
PLAQUES
D'INDICATION,
PEINTURES ET COLLE

11-41

10.11.2003

6250Hi, 6350Hi, 6550Hi, 6650Hi,
6750Hi, 6850Hi, 8050Hi, 8150Hi,
8350Hi, 8450Hi, 8550Hi, 8950Hi

15

VALTRA

Typ _____
 EEC číslo _____
 Výrobní číslo _____
 Celková dovolená hmotnost _____ kg
 Dovol. zatíž.před.náprav _____ kg
 Dovol. zatíž.zadní nápravy _____ kg
 zatíž.závislé na pneumatikách

Dovolená hmotnost připoj.vozidla

-nebrzděný přívěs _____ kg
 -nezávislý brzděný přívěs _____ kg
 -brzděný přívěs _____ kg
 -brzděný přívěs (připojený na brzdový systém (hydraul. nebo pneumat.)) _____ kg

6

WARNING ! ALWAYS APPLY THE PARKING BRAKE AND SHIFT INTO NEUTRAL WHEN PARKING THE TRACTOR. THE ENGINE DOES NOT BRAKE.

ADVARSEL ! SETT ALLTID PÅ PARKERINGSBREMSEN OG SKIFT TIL FRI VED PARKERING.MOTOREN GER IKKE FULL BREMSVIRKING NÅR DEN ER STANSET.

7

WARNING ! ALWAYS APPLY THE PARKING BRAKE AND SHIFT INTO NEUTRAL WHEN PARKING THE TRACTOR. THE ENGINE DOES NOT BRAKE.

ADVARSEL ! SETT ALLTID PÅ PARKERINGSBREMSEN OG SKIFT TIL FRI VED PARKERING.MOTOREN GER IKKE FULL BREMSVIRKING NÅR DEN ER STANSET.

8

VAROITUS ! KÄYTTÄ ANNA KÄSIÄRRUJA JA VÄHÄÄ VAPAALLE KU PYSÄKÖIT. MOOTTORI EI JARRUTA PYSÄKÖITÄESSÄ

VARNING ! DRÅ ALLTID ÅT HANDBROMSEN OCH FRKÖPPLA VÄXELN VID STOP AV TRAKTORN. MOTORN BROMSAR INTE VID STOPP AV TRAKTORN.

9

VAROITUS ! KÄYTTÄ ANNA KÄSIÄRRUJA JA VÄHÄÄ VAPAALLE KU PYSÄKÖIT. MOOTTORI EI JARRUTA PYSÄKÖITÄESSÄ

VARNING ! DRÅ ALLTID ÅT HANDBROMSEN OCH FRKÖPPLA VÄXELN VID STOP AV TRAKTORN. MOTORN BROMSAR INTE VID STOPP AV TRAKTORN.

10

N.B.1 GEBRUIK BIJ PARKEREN VAN DE TRACTOR ALTIJD DE HANDEMN. TRACTOREN MET DELTA POWER SHIFT HEBBEN GEEN MECHANISCHE VERBINDING TUSSEN VERBELLINGSBAK EN MOTOR WANNEER DEZE GESTOPT IS.

N.B.1 TOUJOURS SERRER LE FREIN À MAIN LORSQUE LE TRACTEUR EST À L'ARRÊT. SUR LES TRACTEURS AVEC DELTA PWER SHIF. IL NY A PLUS DE LIASON MÉCANIQUE ENTRE LA BOÎTE DE VITESSES ET LE MOTEUR LORSQU'IL EST STOPPÉ.

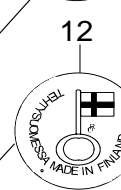
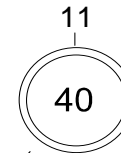
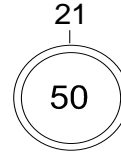

1

VALTRA

Tr. tyyppi / Cab type _____
 Valmistaja no. / Manufact. no. _____
 Töiden hyväksyntä no. _____
 Työsuojusmerkki _____
 CECD approval _____
 EEC approval _____

Suomenkielinen ohjekirja on saatavilla suoraan valmistajalta.

Tr. tyyppi / Tr. type _____

Valmistaja / Manufacturer: Valtra Inc., Finland

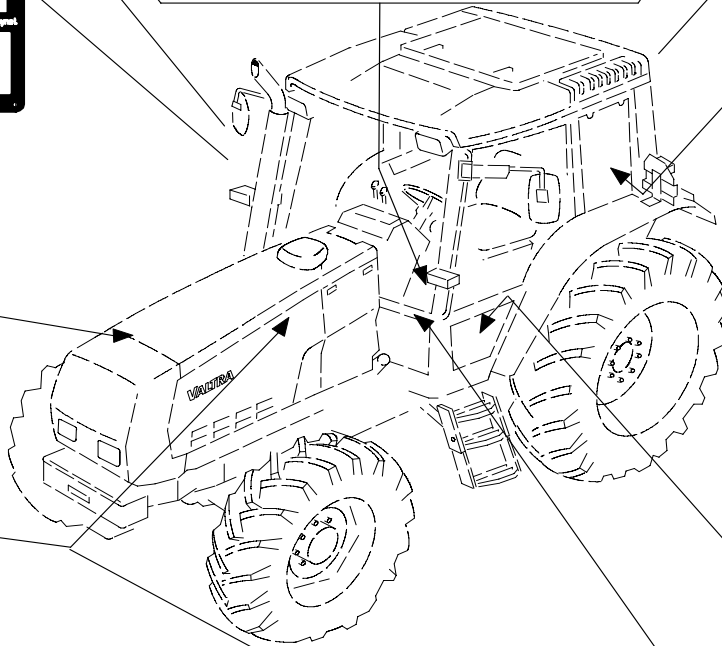
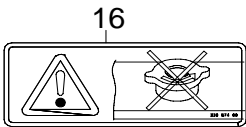

4

STRUCTURE DE SECURITE _____
 MARQUE _____
 TYPE _____ MARQUAGE _____
 HOMOLOGUEE POUR _____

5

HOMOLOGATION
 ACCORDEE AU TYPE: _____
 PAR LE MINISTERE DE L' AGRICULTURE
 SOUS LE NUMERO: _____

3

VALTRA

13

VALTRA

14

VALTRA

17

VALTRA VALMET

19

VALTRA VALMET

18

VALTRA VALMET

20

VALTRA VALMET

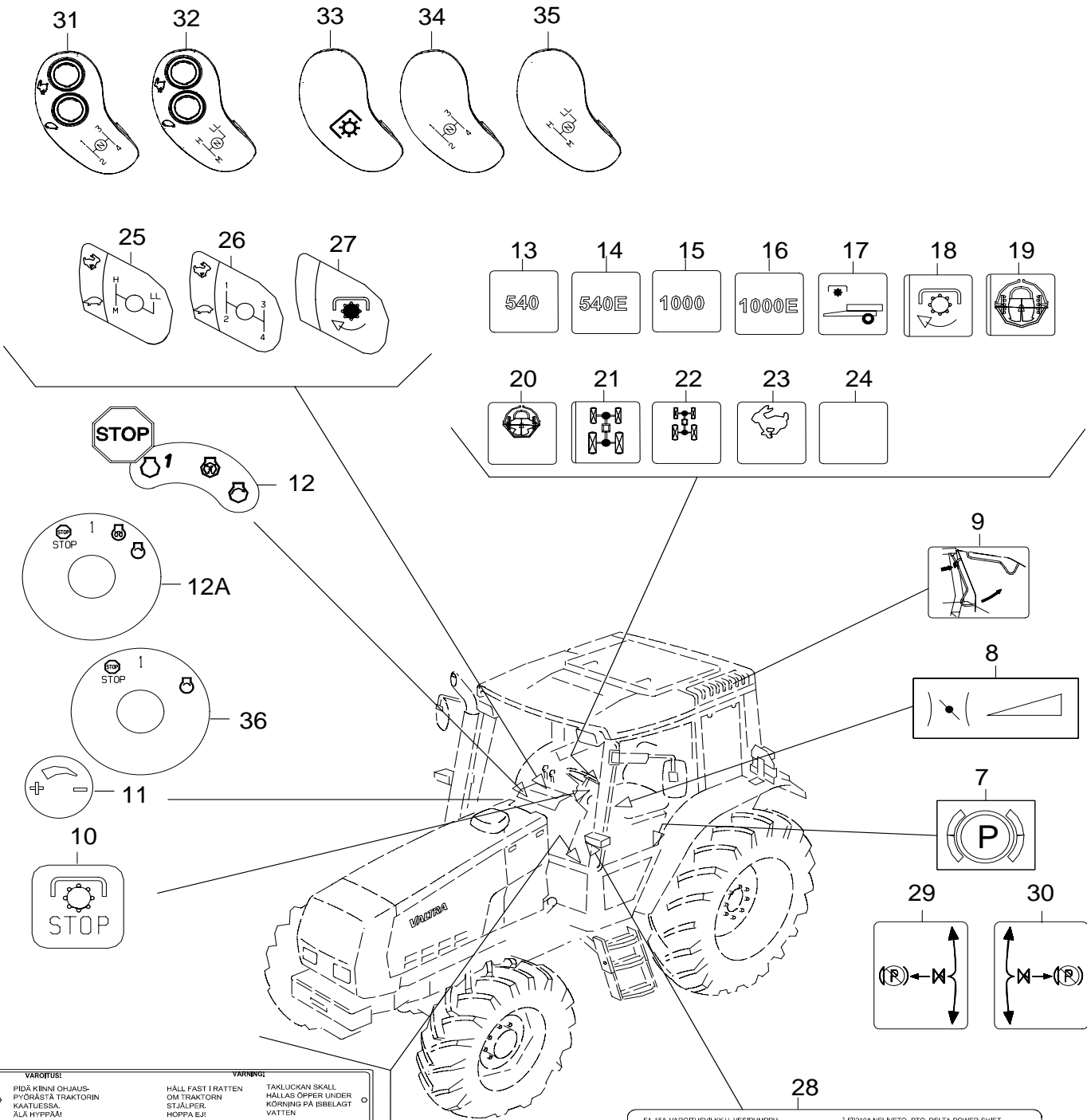

<p>VAROITUS! PIDÄ KÄNNI OHAUS- PYÖRÄSTÄ TRAKTORIN KÄÄTTEISSÄ, ÄLÄ HYPPÄÄ!</p>	<p>VARNING! HÅLL FAST I RATTEN OM TRAKTORN STÄLLER. HOPPA EJ!</p>
<p>CAUTION! CATCH THE WHEEL WITH BOTH HANDS IN CASE THE TRACTOR TURNS OVER. DON'T JUMP IF THE ROOF HATCH MUST BE OPENED WHEN DRIVING ON ICE-COVERED WATER.</p>	<p>ADVARSEL! HOLD FAST I RATTEN HNS TRAKTOREN VELTER. HOPP IKKE AV! HOLD FAST I RATTEN UNDER KØRNING PÅ ISLAGT VANN. KRAFTUTTAKSELEN MED KOPPLINGER SKAL VARE BESKYTTET I HELE SIN LØNDE.</p>
<p>ADVARSEL! HVIS TRAKTOREN VÆLTER HOLD FAST I RATTET. SPRING IKKE AF!</p>	<p>WARNUNG! WENN DER TRAKTOR UMKNIPPT, AM LENKRAD FESTHALTEN UND NICHT HERAUSSPRINGEN!</p>
<p>ATTENTION! WANNNER DE TRAKTOR KANTELIT, HET STUUR STEVIG VASTHOUDEN, NOOIT SPRINGEN!</p>	<p>ATTENTION! SILLE TRACTEUR SE RENVERSE, TENIR LE VOLANT, NE PAS QUITTER LE SIEGE.</p>

F1 15A VAROITUSVLKIU VESIPUMPU
F2 5A RADIO, MITTARISTO, PUHELIN, SÄHK. PÄÄVIR-
TÄIKYTYN, AJOPIRTURI, CARETEL
F 31 5 KÄÄTÖVÄ U. 8 ÄVALO
F4 15A LÄHVÄLÖT
F5 10A SEISONTIWI, LOTI, SEN
F6 10A SEISONTAVALOT, OIKEA
F 72 8 A T LÖYREIÖT
F8 25A VALOKYTYN
F 91 5 R EAMAU N U P I S T CARAKA US HALLVOT
F10 25A 2-NAP. VIRTAFISTORASIA
F11 5A AUKIOCONTROL (+BAT), SUMMERI¹⁾
F 13 10A VARA
F14 10A VÄRTÄLUKKO
F15 25A PUHALIN III-NOPEUS
F16 10A TAKAYÖVALOT, SISEMMÄT
F17 10A VILKUT, FIELOMASTERIGROD ATA¹⁾
F 18 5A MFTAR, MRE, ALOT, AUB
F19 10A TUULILASIN VYHINPESU, RÄNNEMERKKI
F20 10A TUULILASIN PYYHINPESU, RADIO
**F21 15A PUHALIN I II, RUMASTONITLITE,
LÄTTÖPUHALIN**

F2210A NIELIVETO, PTO, DELTA POWER SHIFT
F23 10A TAKAYÖVALOT, ULKOMAT
F2510A VARA
F 21 2 4 PÖÖTÄ J S T U I M U E RÄN T
F26 10A PERUUTUSSUMMERI, SIDA, HESHIFT
F 27 0 4 A R ÄLÖITVÄS B SYÖRÄS ON LU KO
F28 10A VARA
F29 10A TURPAKANSYTYTYN, 2-NAP. VIRTAFISTORASIA
F30 10A CARETEL, 1A JOS IF²⁾

K KYB AB, EEP OVA O
K KYB AB, IKA AYÖVALOT
K3 KYNTÄRELE, TAKASUJUVÄLÖ
K4 APURELE, VIRTÄLUKKO
K5 APURELE, VIRTÄLUKKO
K6 RELE, PUHALIN III-NOPEUS
K7 OHJAUSRELE, NELYOHJÄLÄÄRITUS
¹⁾ JOSS KONEISEN ASENNETTU HANDS FREE
²⁾ MEZZO, MEGA, ³⁾ B H, ⁴⁾ EEM-MALLIT

RA-SULAKKEET

SULAKKEET/RELEET

VALTRA

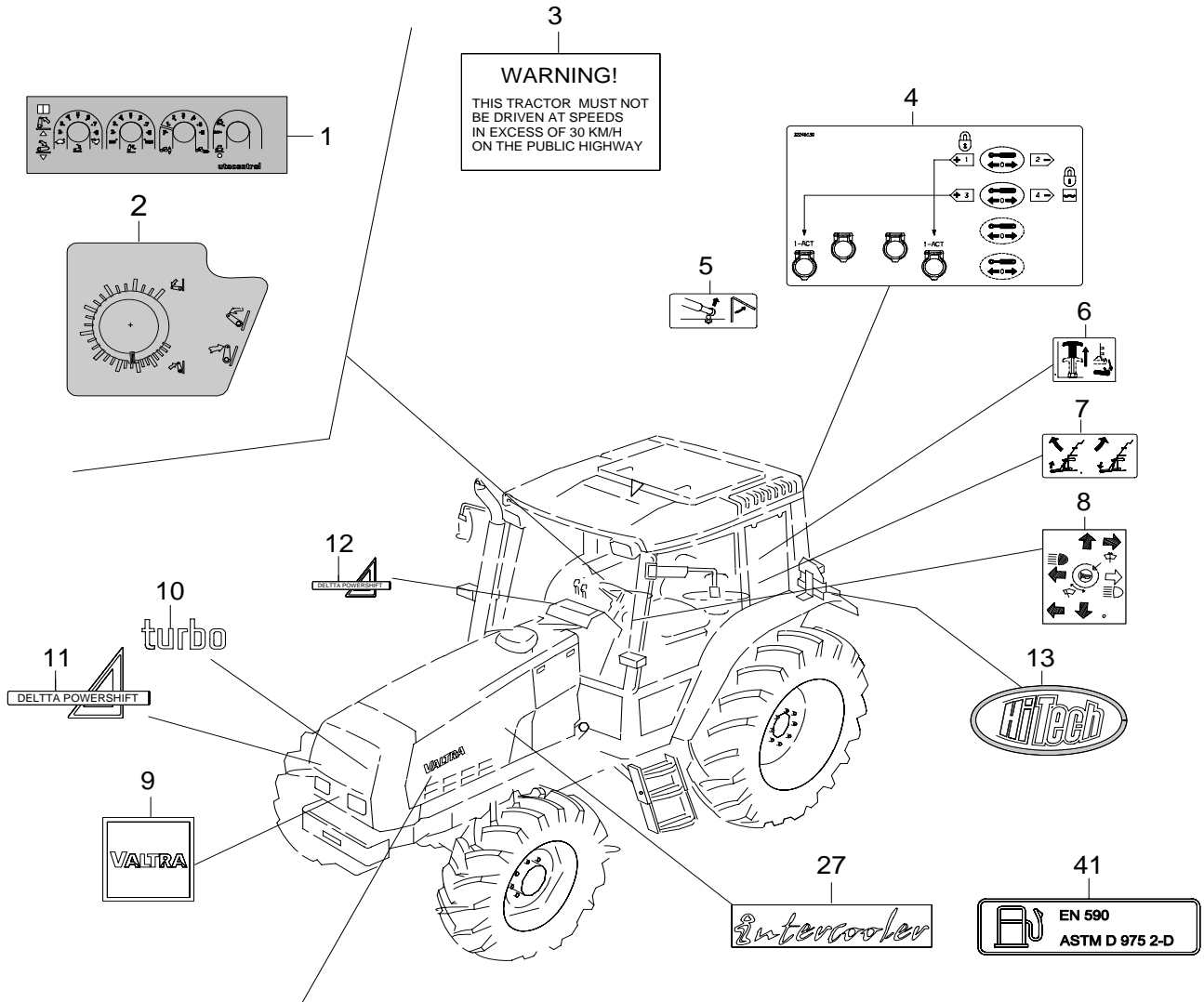

16	—	6250	8050	—	21
17	—	6350	8150	—	22
18	—	6550	8350	—	23
19	—	6650	8450	—	24
20	—	6850	8550	—	25
15	—	6850	8950	—	26

VALTRA VALMET

29	—	6250	40 —	6750	8350	—	36
30	—	6350	33 —	6850	8450	—	37
31	—	6550	34 —	8050	8550	—	38
32	—	6650	35 —	8150	8950	—	39

28 VALTRA

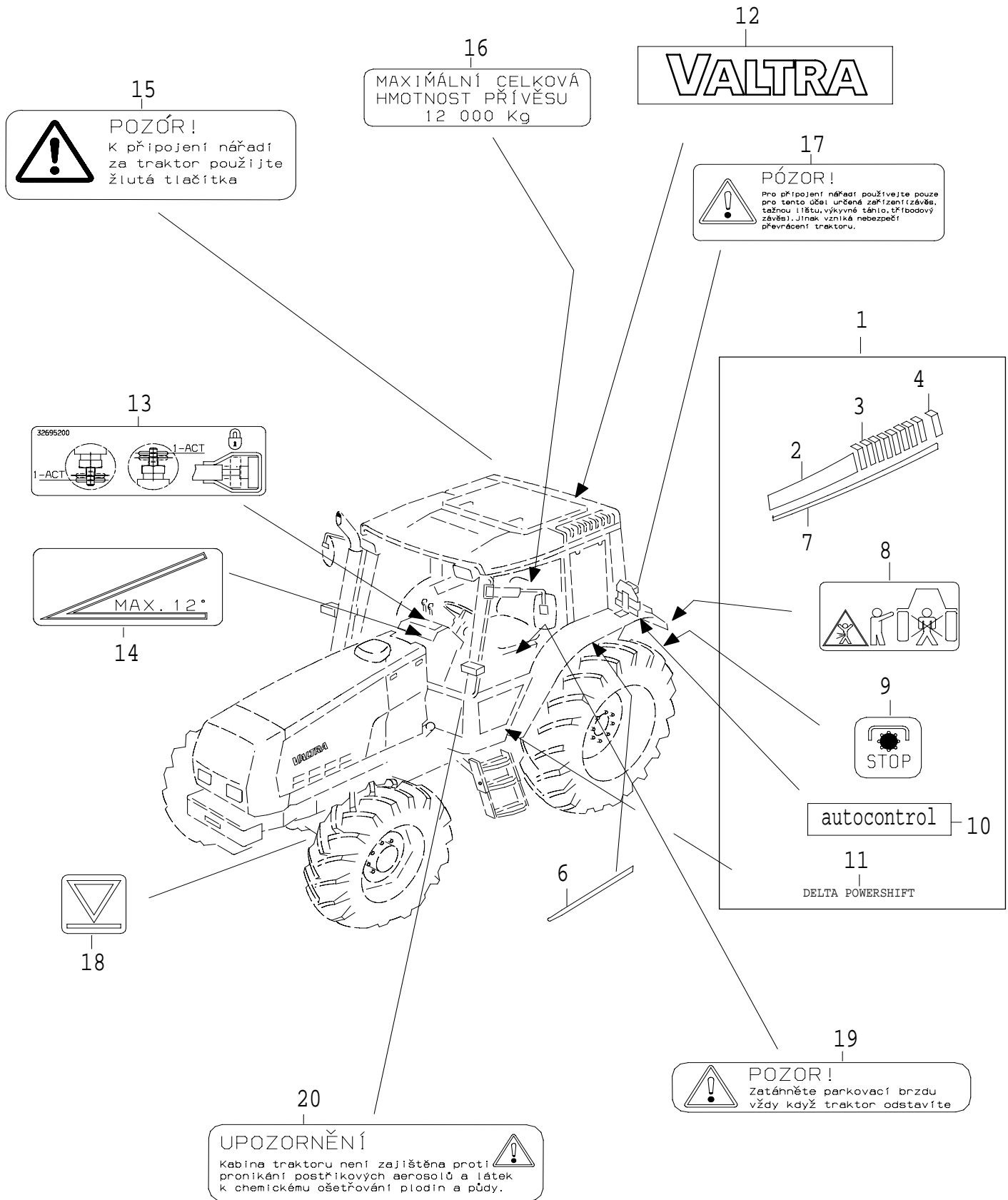

15
POZÓR!
 K připojení nářadí za traktor použijte žlutá tlačítka

16
 MAXIMÁLNÍ CELKOVÁ HMOTNOST PŘÍVĚSU
 12 000 Kg

12
VALTRA

17
PÓZOR!
 Pro připojení nářadí používejte pouze pro tento účel určené zařízení (závěs, těžnou lištu, výkyvné těhlo, třídobový závěs). Jinak vzniká nebezpečí převrácení traktoru.

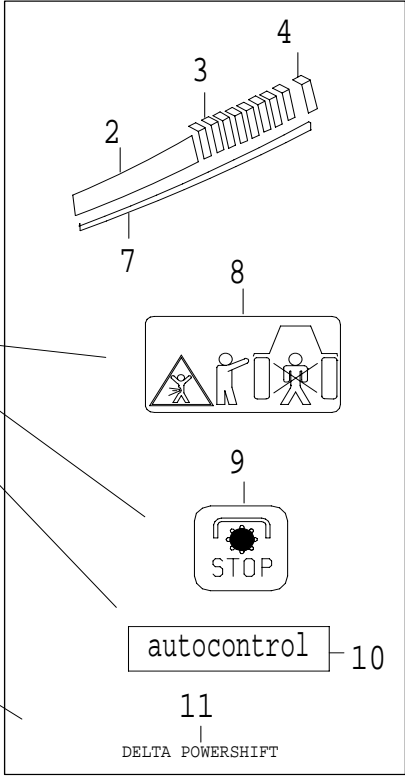
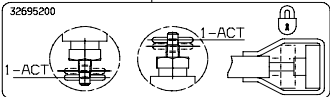

19
POZOR!
 Zetáhněte parkovací brzdou vždy když traktor odstavíte

20
UPOZORNĚNÍ
 Kabina traktoru není zajištěna proti pronikání postřikových aerosolů a látek k chemickému ošetřování plodin a půdy.

16

PULLING TEAM

15

ACHTUNG ! Für eine Notbremsung muss der Handbremshebel links unten am Kabinenboden verwendet werden. Nicht als Parkbremse geeignet.

1

EI PAIKKAA LISÄMATKUSTAJALLE
EJ PLATS FÖR MEDÅKANDE
NO PASSENGERS ALLOWED
UNE PLACE ASSITSEUNIQUEMENT
BEIFAHREER NICHT ZUGELASSEN

4

TAAKSEAJOLAITTEIDEN JARRUPOLJIN EI VAIKUTA PERÄVAINUN JARRU HIN.
DEN BAKKE BROMSPEDALEN PÅVERKAR INTE SLÅPVAGNSBROMSEN.
THE BRAKE PEDAL OF THE REVERSE DRIVE CONTROL DOES NOT INFLUENCE TO THE TRAILER BRAKES
LA PÉDALE DE FREIN DE LA COMMANDE DE LA CONDUITE INVERSÉE N'AGIT PAS SUR LES FREINS DE LA REMORQUE.
BREMSPEDAL DER RÜCKFAHREINRICHTUNG WIRKT NICHT AUF DIE BREMS EN DES ANHÄNGERS.

2

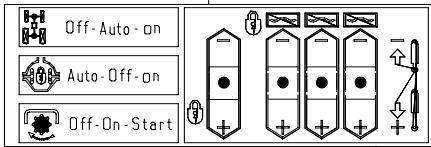

13

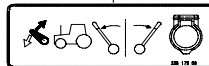

5



6

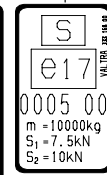

17

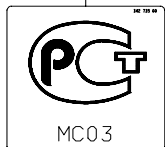

7

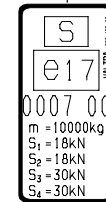

8

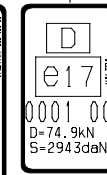

9



10

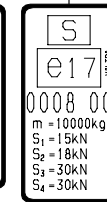

3

VID BRAND
BRYT
HUVUDSTRÖMBRYTARE

12

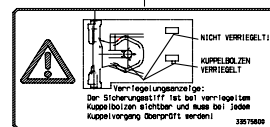

14

ISTUINTA KÄÄNETTÄESSÄ LUKITUSVIPU ASENNOSSA 1
VID VRIDNING AV STOLENSKALL SPÄRRSPAKEN VARA I LÅGE 1
WHEN TURNING THE SEAT THE LOCKING LEVER MUST BE IN POSITION 1
LORS DE LA ROTATION DU SIÈGE, LE LEVIER DE BLOCAGE EST DANS LA POSITION 1
ZUM DREHEN DES SITZES RIEGELSTELLUNG 1

11

FRONTAFTAKAS: GEBRUIK AANDRIJFAS MET VRIJLOOPKOPPELING !
FRONT PTO: FRONT MOUNTED MACHINE MUST HAVE OVER-RUN SLUTCH !
FRONTZAPFWELLE: ANTRIEBSWELLE MIT FREILAUFKUPPLUNG VERWENDE !
PDF AVANT: UTILISER IMPÉRATIVEMENT CARDAN À ROUE LIBRE !



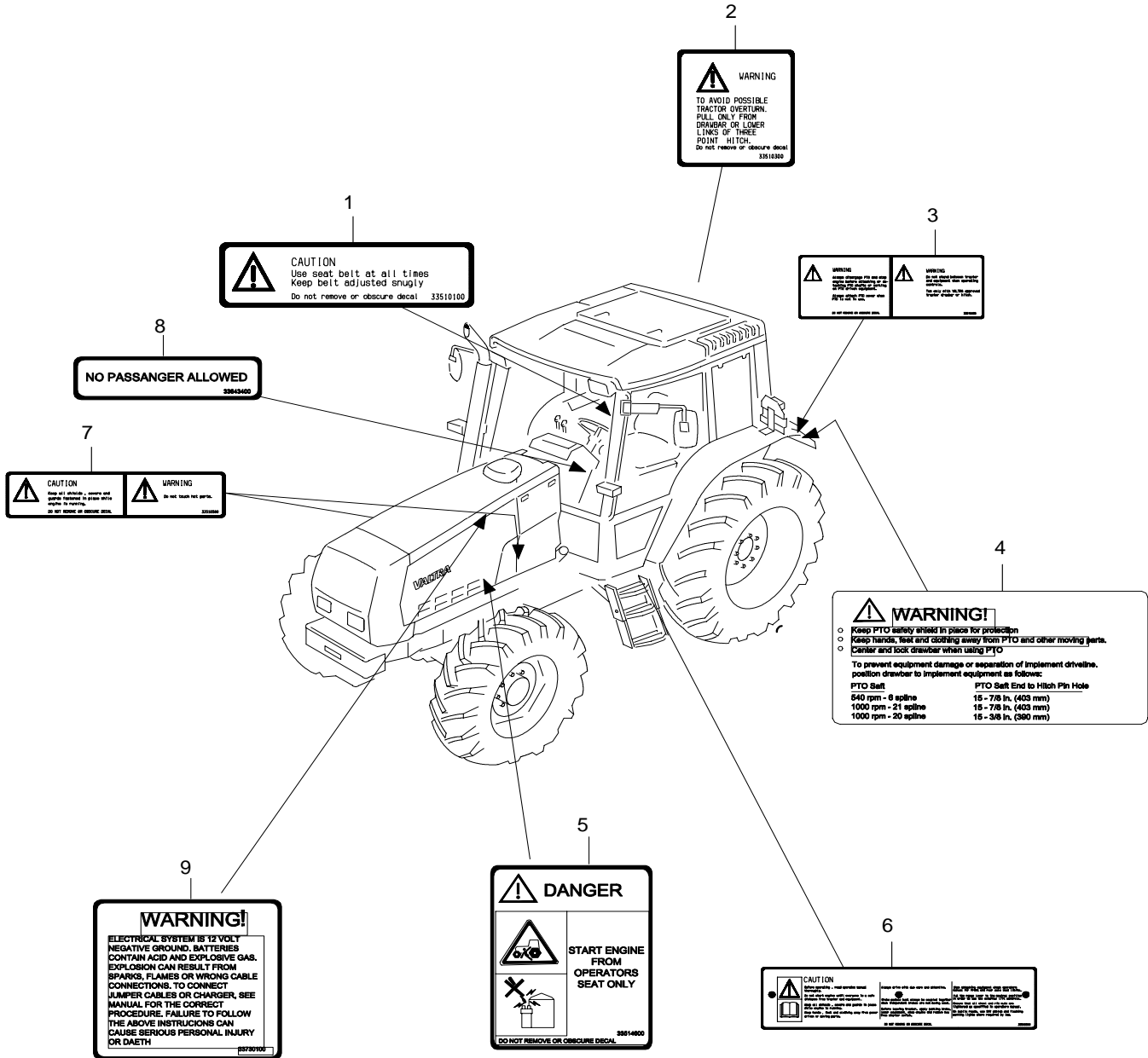

CAUTION



To avoid injury

- Read the Operator's Instruction Book for safety information and operating instructions.
- Fasten your seat belt before tractor operation.
- Start engine only when seated in operator's seat.
- Make sure everyone is clear of tractor and equipment before starting engine or operation.

- Keep all shields, covers and guards in place and stay away from moving parts while engine is running.
- Place transmission shift lever in neutral and apply parking brake before using external 3-point hitch controls.
- Apply parking brake, lower equipment, stop engine and remove key before leaving the tractor unattended.

- Wait for all movement to stop before servicing tractor or equipment.
- Securely support or block lifted implements which must be in the raised position for servicing or adjustment.
- Couple brake pedals together for road travel.
- Use flashing warning lights and SMV emblem when on public roads, except where prohibited by law.
- Always drive with care and attention.

WARNING



Beware of hot surfaces.

36151400

WARNING

Serious personal injury or machine damage may result from overload of PTO driven equipment. Do not operate PTO above recommended maximum speed.

Signal	Maximum
1000	650
1170	1170

For further information refer to operator instruction book.

36149500

WARNING



USE SEAT BELT.

Keep seat belt adjusted snugly.



Do not jump if tractor tips.

36149500

WARNING

Personal injury may result from PTO driveline separation.

DRAWBARs adjust to DISTANCE "A" to suit PTO RPM and SHAFT SIZE.

PTO RPM	SHAFT SIZE	DISTANCE "A"
640	35mm (1.38 in)	350mm (13.78 in)
1000	35mm (1.38 in)	400mm (15.75 in)
1000	45 mm (1.76 in)	500mm (19.69 in)

THREE-POINT HITCH: distance "C" and mounted implement distance "D" may not be standard.

Measure distance "B" over complete lift range for tractor and implement combination. Select driveline length to ensure that driveline will not bottom out at minimum distance "B" and will have sufficient overlap at maximum distance "B".

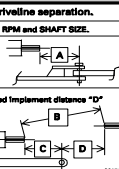

36149500

DANGER



Start only from seat with transmission and PTO in neutral.

Starting in gear kills.

WARNING



Remove negative cables from batteries before removing solenoid cover and before servicing the electrical system.

36150300

WARNING

To prevent serious injury or death from loss of control:

- apply parking brake and shut off engine before turning operator's station;
- do not operate on public roads with operator's station reversed (lighting and marking are not compatible with reverse travel);
- keep brake pedals locked together when operating in reverse position.

36157600

WARNING



High pressure steam and hot water. Remove filler cap with extreme care.

36148700

WARNING



NO RIDERS

36149500

WARNING

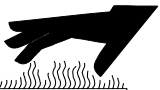

Beware hot parts.



To avoid personal injury, keep all shields, covers and guards in place while engine is running.

36150000

WARNING

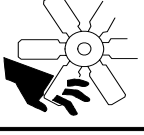



Keep hands clear of fan and belts while engine is running.

36149800

WARNING





Battery posts, terminals, and related accessories contain lead and lead compounds, chemicals known to the State of California to cause cancer and reproductive harm. Wash hands after handling.

36151500

<p>DANGER</p>  <p>Pull only from approved drawbar or lower link of 3-point linkage at horizontal position or below.</p>	<p>DANGER</p>  <p>Rotating driveline contact may cause serious injury or death.</p> <p>Keep all driveline tractor and equipment shields in place during operation.</p>	<p>WARNING</p>  <p>Stand clear when using switch to move 3-point hitch.</p>
--	--	---

36150300

DANGER

 Shield eyes	 Explosive gas	 Avoid sparks and flame	 Sulphuric acid
---	---	--	--

Always shield eyes and face from battery. Cigarettes, flames or sparks could cause battery to explode. Do not charge or use booster cables or adjust post connections without proper instruction or training.

POISON causes severe burns
Contains sulphuric acid. Avoid contact with skin, eyes or clothing. In event of accident flush with water and call a physician immediately. Keep out of reach of children.

36150100

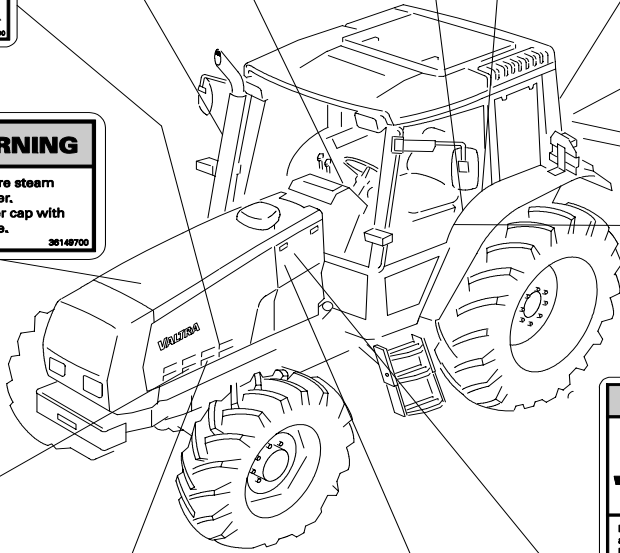

Huomi!
Note!
Linssin asento vaihtelee
Lens position varying

Linssin asennus
Lens adjustment

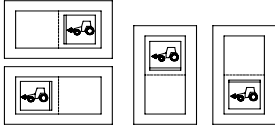

1		20		39		58		77		96		115	
2		21		40		59	AUTO CONTROL	78		97		116	
3		22		41		60	CONTROL STOP	79		98		117	
4		23		42		61	CONTROL STOP	80		99		118	
5		24		43		62	CONTROL STOP	81		100		119	
6		25		44		63	SLIP CONTROL	82		101		120	
7		26		45	AUTO	64		83		102			
8		27		46		65		84	N AUTO	103			
9		28		47		66		85	N AUTO	104			
10		29		48		67		86		105			
11		30		49		68		87		106			
12		31		50		69		88		107			
13		32		51		70	STOP	89		108			
14		33		52		71	DATA	90		109			
15		34		53		72		91		110			
16		35		54		73		92		111			
17		36		55	PUMP	74		93		112			
18		37		56		75		94		113			
19		38		57		76		95		114			



Linssin asennus
Lens adjustment

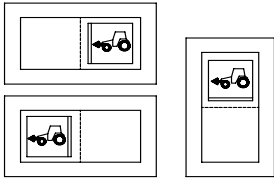

1		18		36	CONTROL STOP	50		69	FL/ RV
2		19		37	CONTROL STOP	51		70	FL
3		20		38		52		71	FL
4		21		39		53		72	
5		22		40	A C A	54		73	
6		23		41	CRUISE	55		74	
7		24		42	AUTO	56		75	
8		25		42A		57		76	
9		26	AUTO	43		59		77	
10		27		44		60	AUTO	78	
11		29		45		61	ISO	79	
12		30	AUTO	46		62	ISO	80	
13		31	5 MAX. min	47		64	N AUTO	81	
14		32	5 MAX. min	48	STOP	65	UP	82	
15		33		49		66	REC 1 0 UP		
16		34				67	FRONT PUMP OFF/ LS		
17		35	AUTO CONTROL			68	LS CP		

OILFILTER ENGINE

6250Hi-6650Hi

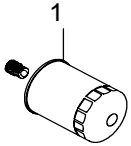

6850Hi-8950Hi

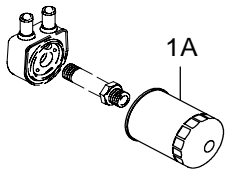

AIRFILTER ENGINE

6250Hi-6850Hi

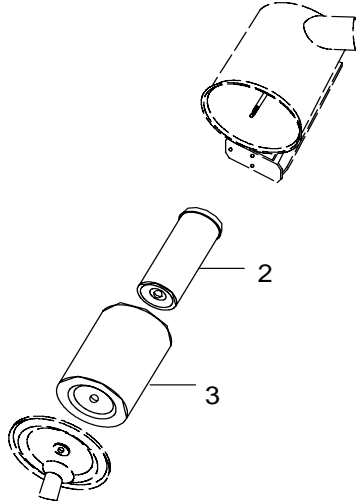

AIRFILTER ENGINE

8050Hi-8950Hi

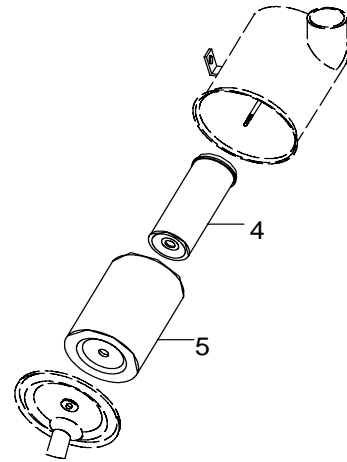

FUEL FILTER

6250Hi-6850Hi

8050Hi-8950Hi

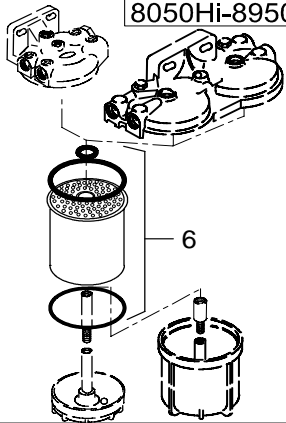

6250Hi-8950Hi

6250Hi, 6350Hi N19960-(M)
6550Hi N11771-(M)
8050Hi, 8150Hi N12129-(M)

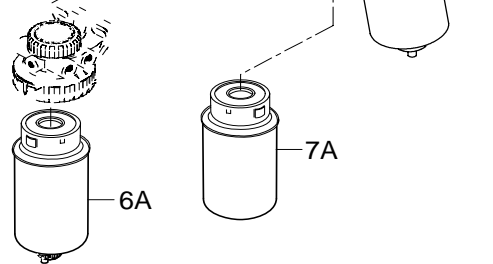

OILFILTER GEARBOX

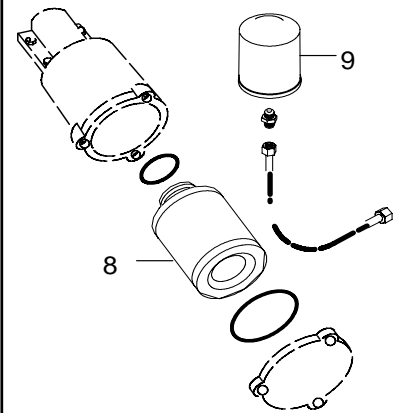

AIRFILTER CAB

FOREST

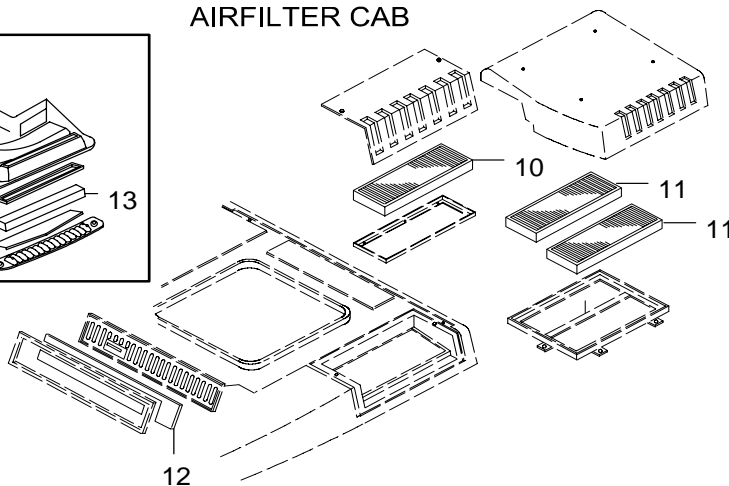
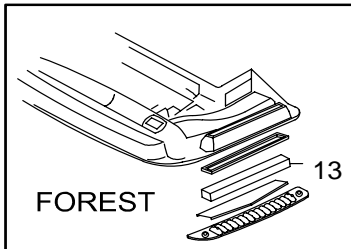

HYDRAULIC AND LOW PRESSURE HYDRAULIC FILTERS

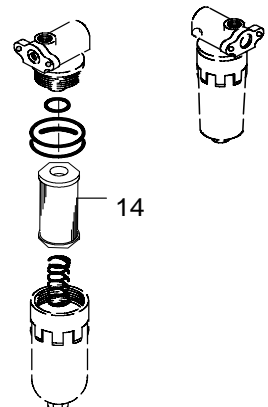

15.8.2005

6250Hi, 6350Hi, 6550Hi, 6650Hi,
6750Hi, 6850Hi, 8050Hi, 8150Hi,
8350Hi, 8450Hi, 8550Hi, 8950Hi

